

Multi-Sensor Controller MU-N Series

NEW



Compatible Sensor Series:

- LR-W Series
- LR-T Series



For standard certification and conformance list, see our website.
www.keyence.com.sg/products/certified/

ASK KEYENCE

www.keyence.com.sg/ASKG



FREE DOWNLOAD

www.keyence.com.sg/DLG

Free downloads for product and technical support are readily available in one convenient location

Network Compatibility

EtherNet/IP™

CC-Link V2

DeviceNet™

EtherCAT®



Enable copying and writing of data via wide varieties of communication protocols.

By pairing the MU-N Series with the KEYENCE NU Series, users can transmit data over a standard industrial network. Compatible networks include EtherNet/IP™, CC-Link, DeviceNet™ and EtherCAT®.

* EtherCAT® is registered trademark and patented technology, licensed by Beckhoff Automation GmbH, Germany.

Settings Back-Up Function

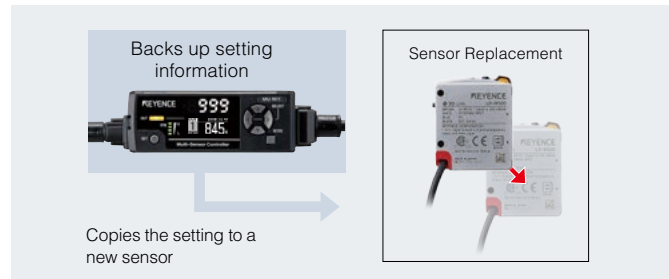

The Settings Back-Up Function allows users to save sensor settings on the MU-N and quickly transfer them to new sensors that are attached.

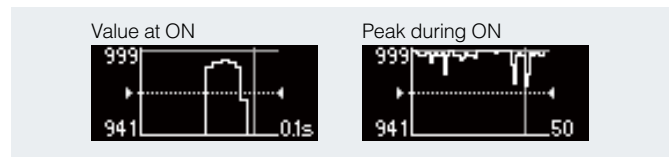

Rich OLED Display



The combination of an OLED and 7-Segment Display allows users to quickly view data in real time. The MU-N also has the ability to display live graphs for easy machine monitoring.

Lineup



Controller

Type	Control output	External input	Analogue output	Model	Weight
 Main unit	4 standard outputs max.*	5 inputs max.*	1 output max.*	MU-N11	Approx. 70 g
 Expansion unit			—	MU-N12	Approx. 70 g

*Six I/O wires available, see instruction manual for applicable wire allocations.

Power supply cable for MU-N Series



Cable is not included with the controller. Must be purchased separately.

Appearance	Applicable unit	Cable material	Cable end*1	Controller side	Length	Supported sensor series	Model	Weight
	Main unit	PVC (Polyvinyl chloride)	8-core loose wires	Connector	2 m	LR-W/LR-T ^{*2}	MU-CB8	Approx. 150 g
			4-core loose wires			LR-W/LR-T	MU-CB4	Approx. 120 g
	Expansion unit		6-core loose wires			LR-W	MU-CB6	Approx. 130 g
			2-core loose wires			LR-W/LR-T	MU-CB2	Approx. 100 g
	Main unit		M12 4-pin straight		0.3 m	LR-W/LR-T	MU-CC4	Approx. 30 g

*1 If you are using the LR-W series, select according to the number of inputs and outputs you require.

*2 For the LR-T Series, if the input/output setting is analogue output + external input only, use the **MU-CB8** (8-core strand wire).



Sensor-to-controller cable (for 4-pin M12 connector type)

Appearance	Cable material	Sensor side	Controller side	Length	Model	Weight
	PVC (Polyvinyl chloride)	M12 4-pin straight	Connector	2 m	OP-88025	Approx. 75 g
				10 m	OP-88026 ^{*1}	Approx. 280 g
		M12 4-pin L-shape		2 m	OP-88027	Approx. 75 g
				10 m	OP-88028 ^{*1}	Approx. 280 g



*1 The 10 m cable includes one spare connector for the controller side.

Connector set for sensor-to-controller connection

This set is required when the sensor cable end is loose wires or when the sensor-to-controller cable is cut.

Appearance	Type	Applicable model	Model	Weight
	For PVC (Polyvinyl chloride) cable	LR-TB2000/TB5000 LR-W500, LR-W70, LR-WF10 OP-75721/87272/85502 OP-75722/87273/87274	OP-88029	Approx. 3 g
	For PUR (Polyurethane) cable	OP-87636/87637 OP-87640/87641	OP-88030	Approx. 3 g

Controller mounting options

Appearance	Type	Description	Model	Weight
	Mounting adapter (for main unit)	Allows the main unit to be mounted without a DIN rail.	OP-76877	Approx. 11 g
	End unit (for expansion)	Used to secure the main and expansion units to DIN rail from both ends. End units must be used when an expansion unit is connected. (2 pieces included)	OP-26751	Approx. 15 g

Specifications (When used with the LR-W Series)

Model	MU-N11 Main unit			MU-N12 Expansion unit			
	LR-W500(C)	LR-W70(C)	LR-WF10(C)	LR-W500(C)	LR-W70(C)	LR-WF10(C)	
Connected sensor							
Response time	Single output: 300 µs/1.1 ms/11 ms/ 100 ms/500 ms selectable Multiple output: 2 ms/3 ms/11 ms/ 100 ms/500 ms selectable	1-Spot Mode Single output: 300 µs/1.1 ms/11 ms/ 100 ms/500 ms selectable 2-Spot Mode Difference Monitoring: 600 µs/2.6 ms/21 ms/ 200 ms/1 s selectable 2-Spot Mode 2-Point Matching: 500 µs/2.1 ms/21 ms/ 200 ms/1 s selectable 1-Spot Mode Multiple outputs: 2 ms/3 ms/11 ms/100 ms/ 500 ms selectable 2-Spot Mode Multiple outputs: 2 ms/4 ms/21 ms/200 ms /1 s selectable	Single output: 350 µs/1.2 ms/13 ms/ 120 ms/600 ms selectable Multiple output: 3 ms/4 ms/14 ms/ 120 ms/600 ms selectable	Single output: 300 µs/1.1 ms/11 ms/ 100 ms/500 ms selectable Multiple output: 2 ms/3 ms/11 ms/ 100 ms/500 ms selectable	1-Spot Mode Single output: 300 µs/1.1 ms/11 ms/ 100 ms/500 ms selectable 2-Spot Mode Difference Monitoring: 600 µs/2.6 ms/21 ms/ 200 ms/1 s selectable 2-Spot Mode 2-Point Matching: 500 µs/2.1 ms/21 ms/ 200 ms/1 s selectable 1-Spot Mode Multiple outputs: 2 ms/3 ms/11 ms/100 ms/ 500 ms selectable 2-Spot Mode Multiple outputs: 2 ms/4 ms/21 ms/200 ms /1 s selectable	Single output: 350 µs/1.2 ms/13 ms/ 120 ms/600 ms selectable Multiple output: 3 ms/4 ms/14 ms/ 120 ms/600 ms selectable	
Mutual interference reduction function	Up to 2 units with alternate frequencies set						
Timer	OFF/OFF delay/ON delay/One-shot						
Power supply	Power voltage	24 VDC, ripple (P-P) 10% or less, Class 2 or LPS					
	Current consumption	135 mA or less (without load) 335 mA or less (when 4 outputs are used, with load)	130 mA or less (without load) 330 mA or less (when 4 outputs are used, with load)	120 mA or less (without load) 320 mA or less (when 4 outputs are used, with load)	120 mA or less (without load) 200 mA or less (when 4 outputs are used, with load)	115 mA or less (without load) 195 mA or less (when 4 outputs are used, with load)	105 mA or less (without load) 185 mA or less (when 4 outputs are used, with load)
I/O	Control output	4 outputs max. NPN open collector/PNP open collector selectable 24 VDC or less, main unit: 50 mA or less ^{*1} , expansion unit: 20 mA or less Remaining voltage: 2 V or less N.O./N.C. selectable					
	External input	5 inputs max. Short circuit current: 1 mA or less for NPN/2 mA or less for PNP For the applied voltage, see the wiring diagrams in the instruction manual.					
	Analogue output	1 output max. Current output/Voltage output selectable Current output: 4 to 20 mA Maximum load resistance: 450 Ω Voltage output: 0 to 10 V External load resistance: 5 kΩ or more			—		
Protection circuit	Protection against reverse power connection, power supply surge, output overcurrent, output surge, and reverse output connection						
Unit expansion	Up to 4 units per main unit ^{*2}						
Environmental resistance	Ambient temperature	-20 to +50°C (no freezing)					
	Ambient humidity	35 to 85%RH (no condensation)					
	Shock resistance	1000 m/s ² in X, Y, Z axis directions respectively 6 times					
	Vibration resistance	10 to 55 Hz Double amplitude 1.5 mm in the X, Y, Z axis directions respectively, 2 hours					
Material	Case and dust cover: Polycarbonate, Button: Polyacetal, Display panel: Acrylic						
Weight	Approx. 70 g						

*1 20 mA or less when an expansion unit is connected.

*2 Up to 5 N-bus devices, including the main unit (or network unit), can be linked together.

Input/Output Circuits (When used with the LR-W Series)

Control output circuit

When NPN is selected

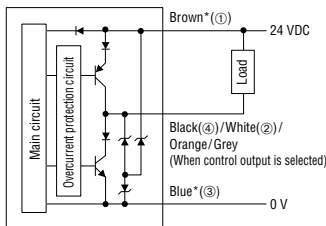

When PNP is selected

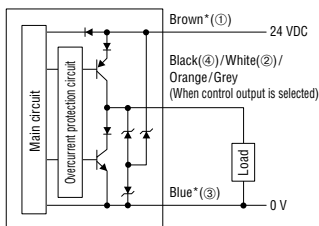

* MU-N11 only

Input circuit

When NPN is selected

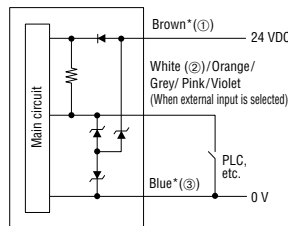

When PNP is selected

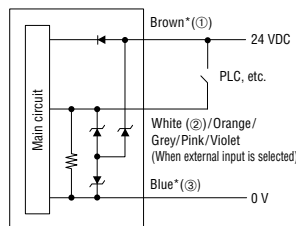

Analogue output circuit *

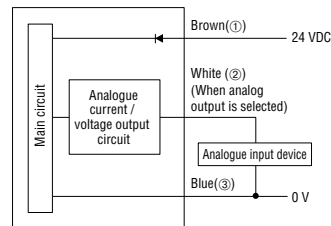

Pin layout when the M12 connector (4-pin) cable is used



Power Cable wire colours

MU-N11 (main unit)

Wire colour	Details	Power cable model/type
Brown (1*)	24 V	MU-CB4 4-core cable for main unit (MU-CC4-M12 connector type)
Blue (3*)	0 V	
Black (4*)	Output 1	
White (2*)	Output 2/ Input 1/ Analogue	
Orange	Output 3/ Input 2	MU-CB8 8-core cable for main unit
Grey	Output 4/ Input 3	
Pink	Input 4	
Violet	Input 5	

MU-N12 (expansion unit)

Wire colour	Details	Power cable model/type
Black	Output 1	MU-CB2 2-core cable for expansion unit
White	Output 2/ Input 1	
Orange	Output 3/ Input 2	MU-CB6 6-core cable for expansion unit
Grey	Output 4/ Input 3	
Pink	Input 4	
Violet	Input 5	

* Pin numbers when using an M12 connector cable

Specifications(When used with the LR-T Series)

Model		MU-N11	MU-N12
Main unit/expansion unit		Main unit	Expansion unit
Response time		LR-TB5000(C), LR-TB2000(C): 7 ms/15 ms/30 ms/105 ms/1000 ms selectable LR-TB5000CL, LR-TB2000CL: 8 ms/25 ms/55 ms/205 ms/2000 ms selectable	
Timer		OFF/OFF delay/ON delay/One-shot	
Power supply	Power voltage	24 VDC, ripple (P-P) 10% or less, Class 2 or LPS	
	Current consumption	LR-TB5000(C/CL) connected: 120 mA or less*1 LR-TB2000(C/CL) connected: 115 mA or less*1	LR-TB5000(C/CL) connected: 105 mA or less*2 LR-TB2000(C/CL) connected: 100 mA or less*2
I/O*3	Control output	Maximum 2 outputs NPN open collector/PNP open collector selectable Main unit: 24 VDC or less, 50 mA*4 or less, residual voltage: 2 V or less, N.O./N.C. selectable Expansion unit: 24 VDC or less, 20 mA or less, residual voltage: 2 V or less, N.O./N.C. selectable	
	External input	Maximum 1 input Transmission OFF / tuning / reference surface update selectable Short-circuit current: 1 mA or less for NPN/2 mA or less for PNP For the applied voltage, see the wiring diagrams in the User's Manual (LR-T Edition). For the input times, see the time charts in the User's Manual (LR-T Edition).	
	Analog output	Maximum 1 output Current output/voltage output selectable Current output: 4 to 20 mA with a max. load resistance of 450 Ω Voltage output: 0 to 10 V with an external load resistance of 5 kΩ or more	—
Protection circuit		Protection against reverse power connection, power supply surge, output overcurrent, output surge, and reverse output connection	
Unit expansion		Up to 4 units per main unit*5	
Environmental resistance	Ambient temperature	-20 to +50°C (no freezing)	
	Ambient humidity	35 to 85%RH (no condensation)	
	Shock resistance	1000 m/s ² in X, Y, Z axis directions respectively 6 times	
	Vibration resistance	10 to 55 Hz Double amplitude 1.5 mm in the X, Y, Z axis directions respectively, 2 hours	
Material		Case and dust cover: Polycarbonate, Button: Polyacetal, Display panel: Acrylic	
Weight		Approx. 70 g	

*1 LR-TB5000(C/CL) connected: 220 mA or less (2 outputs, including load), LR-TB2000(C/CL) connected: 215 mA or less (2 outputs, including load)
 *2 LR-TB5000(C/CL) connected: 145 mA or less (2 outputs, including load), LR-TB2000(C/CL) connected: 140 mA or less (2 outputs, including load)
 *3 The I/O settings can be selected from the following combinations.
 Main unit: Control output × 2, control output + external input, control output + analogue output, analogue output + external input
 Expansion unit: Control output × 2, control output + external input
 *4 20 mA or less when using the expansion unit.
 *5 Up to 5 N-bus devices, including the main unit (or network unit), can be linked together.

Input/Output Circuits (When used with the LR-T Series)

Control output circuit

When NPN is selected

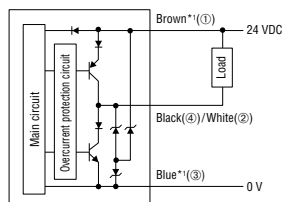

When PNP is selected

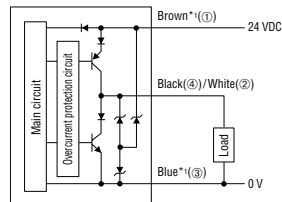

Input circuit

When NPN is selected

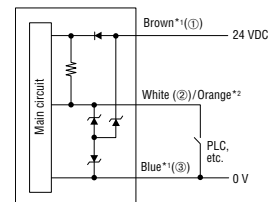

When PNP is selected

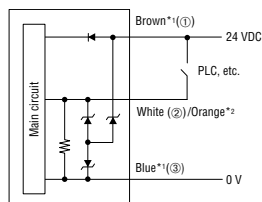

Analogue output circuit *1

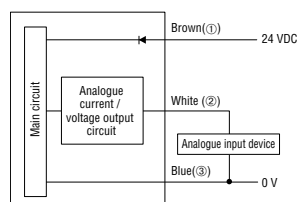

Pin layout when the M12 connector (4-pin) cable is used



*1 MU-N11 only

*2 When the I/O setting is "analogue output + external input", the power supply cable should be MU-CB8(8-core loose wires). In this case, the white wire corresponds to the "analogue output" and the orange wire corresponds to the "external input".

MU-N11 (Main unit)

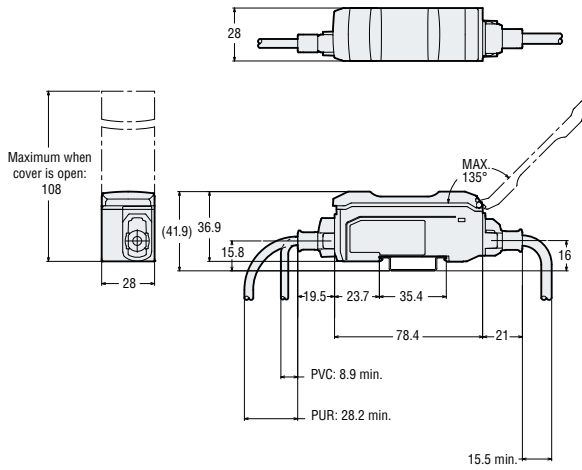

MU-N12 (Expansion unit)

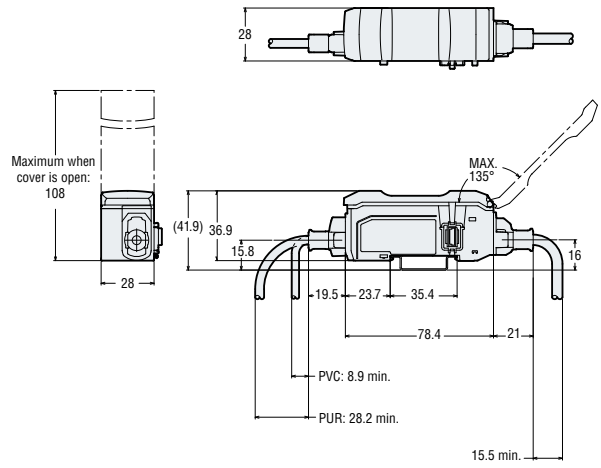

When mounting adapter is attached
(OP-76877, optional, sold separately)

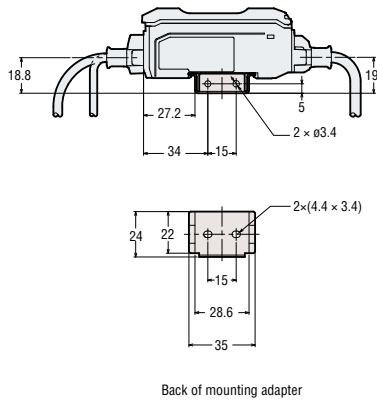

When the communication unit is connected without using a power supply cable

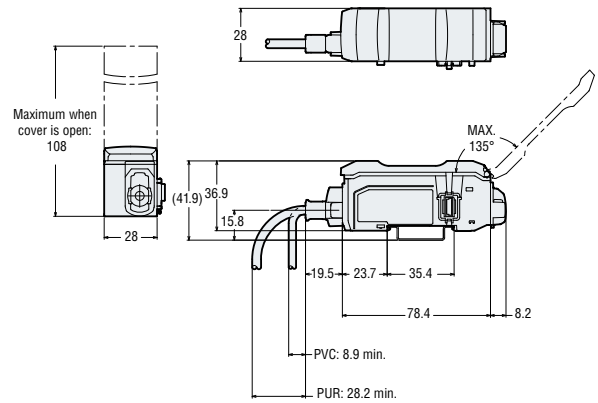

When expansion units are connected

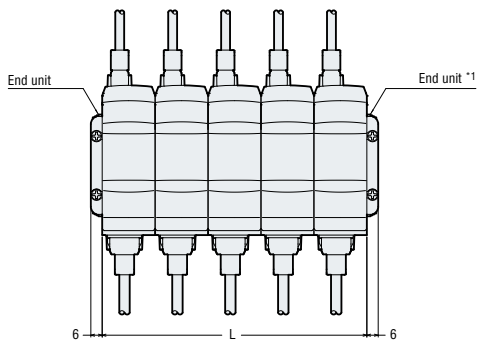

End unit (OP-26751, optional, sold separately)

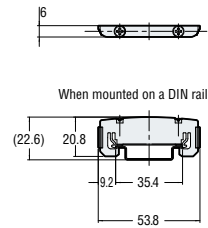

*1 End units must be used when an expansion unit is connected. (Optional)

No. of expansion units	L
1	28
2	56
3	84
4	112
5	140

M12 connector cable for sensor

OP-75721/87272/85502

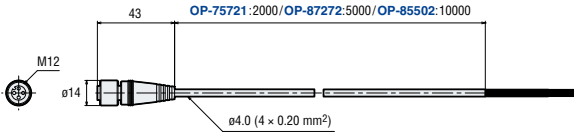

OP-75722/87273/87274

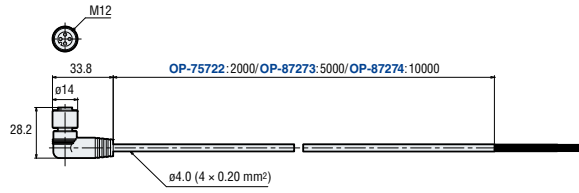

OP-87636/87637

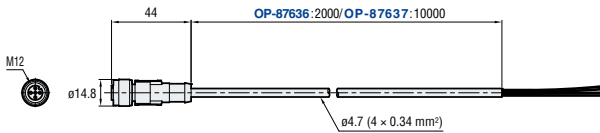

OP-87640/87641

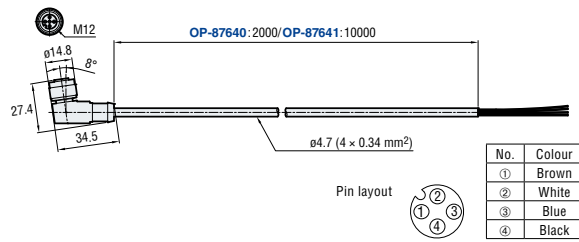

Power supply cable for MU-N

MU-CB8/CB4/CB6/CB2

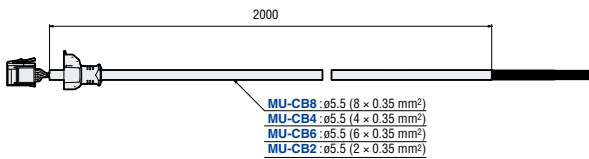

MU-CC4

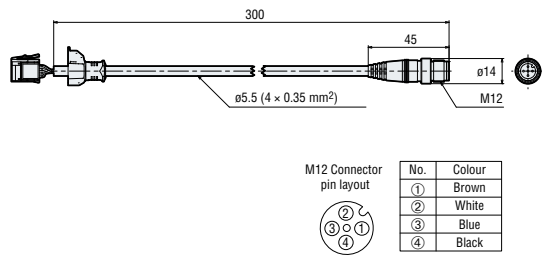

Sensor-to-controller cable (4-pin M12 connector type)

OP-88025/88026

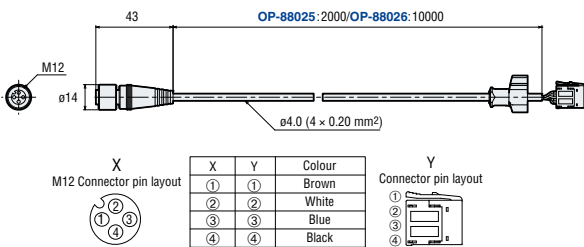

OP-88027/88028

